

# ECO BOX



## Szuflady ECO BOX 41, 42, 43

Drawers ECO BOX 41, 42, 43

**BOX-41**



INDEX	[K]	H (mm)	L (mm)
BOX-41-89-300-...		89	300
BOX-41-89-350-...		89	350
BOX-41-89-400-...		89	400
BOX-41-89-450-...		89	450
BOX-41-89-500-...		89	500
BOX-41-89-550-...		89	550

[K] =  W  A

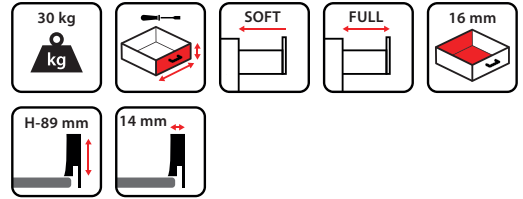

**BOX-42**



INDEX	[K]	H (mm)	L (mm)
BOX-42-121-300-...		121	300
BOX-42-121-350-...		121	350
BOX-42-121-400-...		121	400
BOX-42-121-450-...		121	450
BOX-42-121-500-...		121	500
BOX-42-121-550-...		121	550

[K] =  W  A

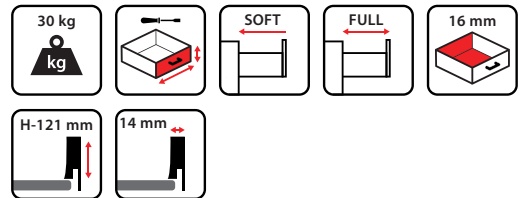

**BOX-43**



INDEX	[K]	H (mm)	L (mm)
BOX-43-185-300-...		185	300
BOX-43-185-350-...		185	350
BOX-43-185-400-...		185	400
BOX-43-185-450-...		185	450
BOX-43-185-500-...		185	500
BOX-43-185-550-...		185	550

[K] =  W  A

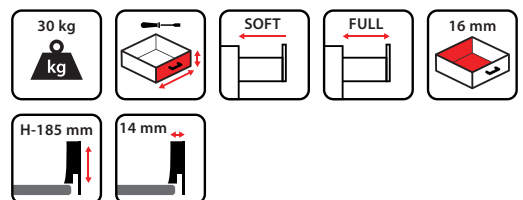



**Udźwig do 30 kg** pozwala na wykorzystanie szuflad do różnych zastosowań także przy dużych obciążeniach. Przeprowadzone testy w laboratorium Gamet potwierdzają, że taki właśnie udźwig szuflad zapewnia ich bezawaryjną pracę przez lata.

**Load capacity up to 30 kg** allows to use drawers for a variety of applications including heavy loads. Tests carried out in the Gamet laboratory confirm that load capacity of drawers ensures their trouble-free operation for years.

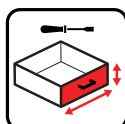

**Regulacja w 2 wymiarach** (pion i poziom) oszczędza czas montażu szuflady i tym samym zapewnia komfort pracy.

**Adjustment in 2 dimensions** (vertical and horizontal) saves drawer assembly time and thus ensures comfort of work.

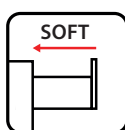

**Cichy domytek** zapewnia ciche i komfortowe korzystanie z szuflady.

**The soft closing** ensures quiet and comfortable drawer usage.

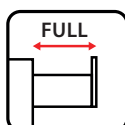

**Pełny wysuw** gwarantuje swobodny dostęp do całej powierzchni szuflady i jej wysoką funkcjonalność.

**Full extension** guarantees easy access to the entire surface of the drawer and its high functionality.

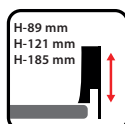

**3 wysokości** dają duże możliwości w projektowaniu mebli oraz pozwalają użytkownikowi na lepszą organizację produktów wewnątrz szuflad.

**3 heights** give great possibilities in furniture design and allow the user to better organize products inside drawers.



**Cieńkościenna konstrukcja o wymiarze zaledwie 14 mm** zapewnia jeszcze więcej przestrzeni wewnątrz szuflady oraz wpisuje się w nowoczesny i uniwersalny design, który sprawdza się w meblach w różnym stylu.

**The thin-walled construction with a dimension of just 14 mm** provides even more space inside the drawer and fits in with a modern and universal design that works in furniture in a variety of styles.



**2 uniwersalne kolory: biały i antracytowy** pozwalają na aranżowanie szuflad do mebli w różnej kolorystyce.

**2 universal colors: white and anthracite**, allows to arrange furniture drawers in different colors.



## BUDOWA SZUFLADY / DRAWER CONSTRUCTION

1. Prowadnica L/P // Slides R/L
2. Profil szuflady ECO BOX: L/P // ECO BOX Drawer profile: L/R
3. Mocowania frontu do ECO BOX 41, 42, 43 //  
ECO BOX 41, 42, 43 front fixing brackets
4. Mocowania frontu do ECO BOX 43 //  
ECO BOX 43 front fixing brackets
5. Zaślepka // Side cover plate
6. Tył szuflady // Drawer back
7. Dno szuflady // Drawer bottom
8. Front szuflady // Drawer front
9. Klip // Locking brackets

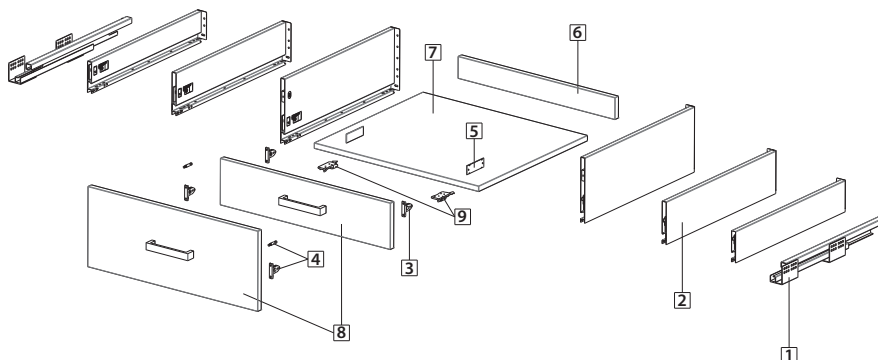

## DŁUGOŚCI / LENGHTS

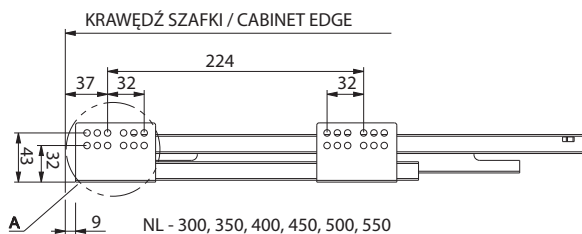

## WYMIARY TYŁU I DNIA SZUFLADY / DRAWER BACK AND BOTTOM DIMENSION

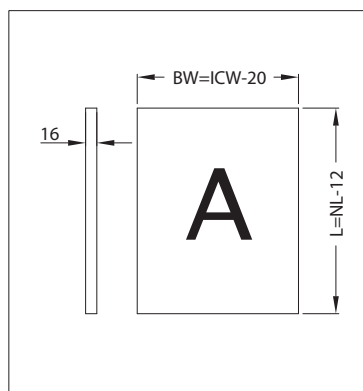
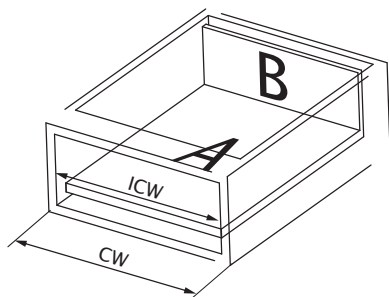

NL	ML
300 mm	305 mm
350 mm	355 mm
400 mm	405 mm
450 mm	455 mm
500 mm	505 mm
550 mm	555 mm

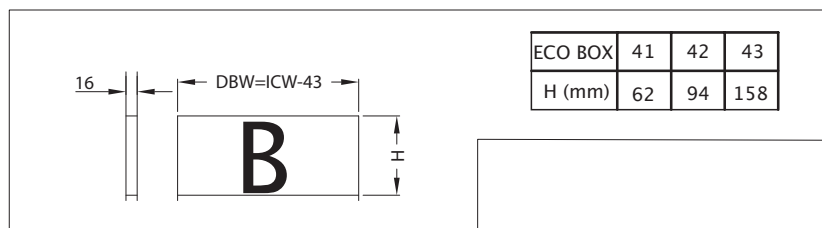

- CW - szerokość korpusu // cabinet width  
 ICW - wewnętrzna szerokość korpusu // internal cabinet width  
 NL - nominalna długość // nominal length  
 ML - minimalna głębokość korpusu // Minimal cabinet depth  
 L - długość dna szuflady // drawer bottom length  
 BW - szerokość dna szuflady // drawer bottom width  
 H - wysokość tyłu szuflady // drawer back height  
 DBW - szerokość tyłu szuflady // drawer back width



GAMET S.A.  
ul. Chrzanowskiego 33  
87-100 Toruń  
Poland



EUROPEAN MANUFACTURER OF FURNITURE ACCESSORIES

Biuro Obsługi Klienta / Customer Service Office

PL +48 56 646 22 00  
EN +48 56 611 01 80  
RU +48 56 611 01 75  
DE +48 56 611 01 57  
DE +49 152 5401 5818  
fax +48 56 611 00 01

 /Gamet.eu

 /gamet\_sa

 /gamet\_sa

 /gamet-s-a

 /GametSA

gamet@gamet.eu  
www.gamet.eu  
www.decoris.eu  
uslugi.gamet.eu  
styl.gamet.eu  
www.furteco.es

